

1.

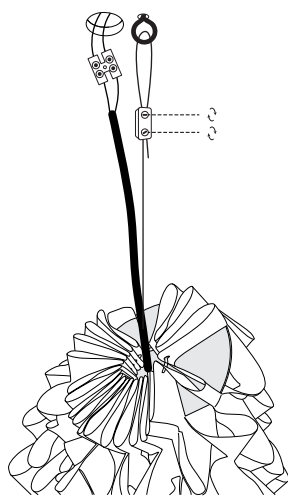

Carefully unpack the lamp and untwine the electric wire and suspension cable. Mark and drill a hole next to the house wire. Use a dowel and a hook (by client); JSPR ceiling fasteners or JSPR canopy (instructions in this manual).

Attach the suspension cable to the hook/JSPR ceiling fastener, adjust desired cable length and tighten the cable fastener. Trim excess cable. Connect the electricity using electric connection blocks. and proceed to arrange the top plate of the lamp.

2.

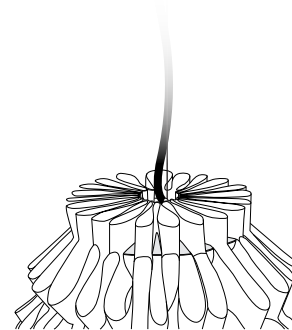

Level the flaps on top around the stainless steel plate until the fixture levels out. continue to arrange the layers and level the top plate as necessary.

3.

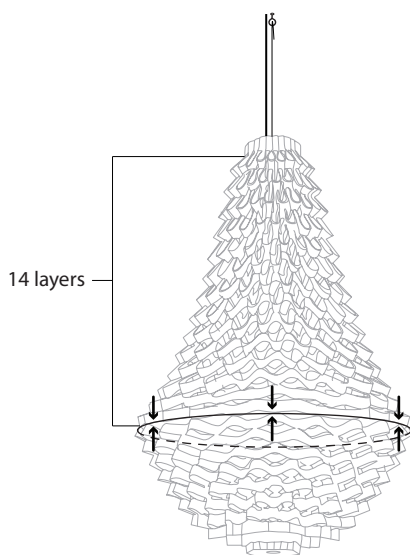

3.

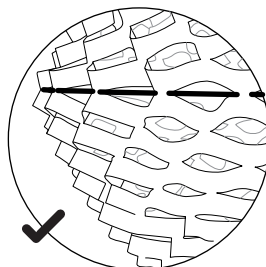
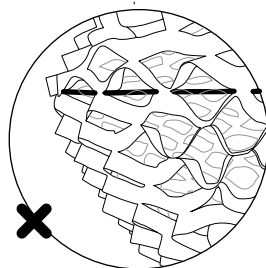

Even though all lamps are pre - assembled before packaging during shipping it's possible that the centre ring has tilted. Arrange the ring back in its position between the 14th and 15th layer from top. And correct any twisted layers.

For video instructions check Crown collection. <https://www.jspr.eu/collection/crown>

4.

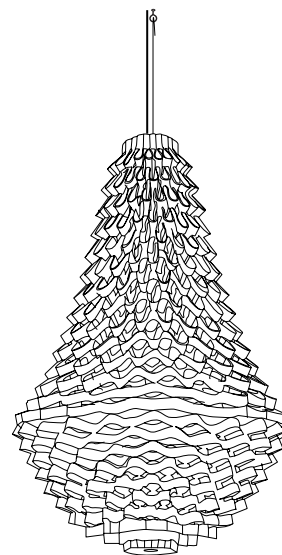

CONTACT

JSPR  
T +31 (0) 402692111  
INFO@JSPR.EU  
WWW.JSPR.EU

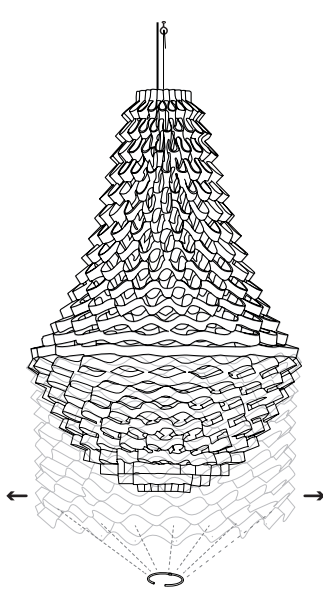

To replace the large bulb the light fixture must be opened from the bottom. Carefully locate the bottom ring and unclick to open the ring.

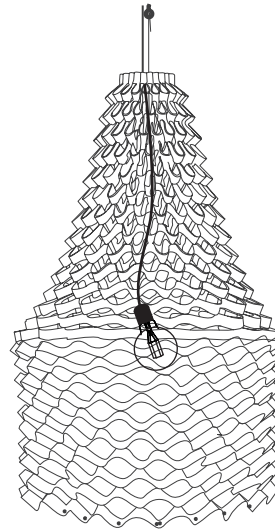

Loosen as much layers as necessary to easily reach and replace the bulb.

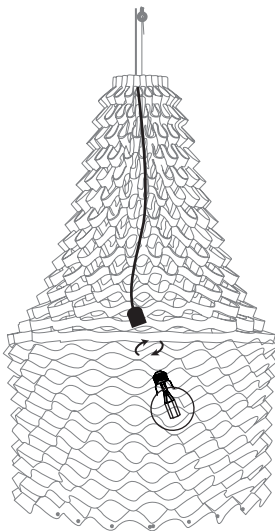

Unscrew the old bulb and replace with new LED bulb max 100W. Screw thread E27.

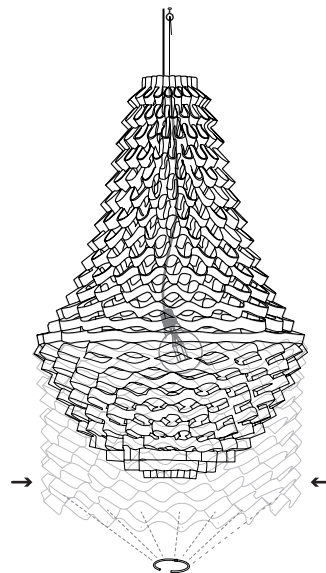

Once the bulb is replaced, locate all the loose layers and sequentially thread back the loose layers and click the ring together.

CONTACT

JSPR  
T +31 (0) 402692111  
INFO@JSPR.EU  
WWW.JSPR.EU

**The Large Crown will always be delivered assembled, but in case of maintenance or bulb replacement it's useful to know the construction of the light fixture.**

Carefully unpack the lamp and all its components. Untwine the electric wire and cable for hanging. Mark and drill a hole next to the house wire. Use a dowel and a hook (by client).

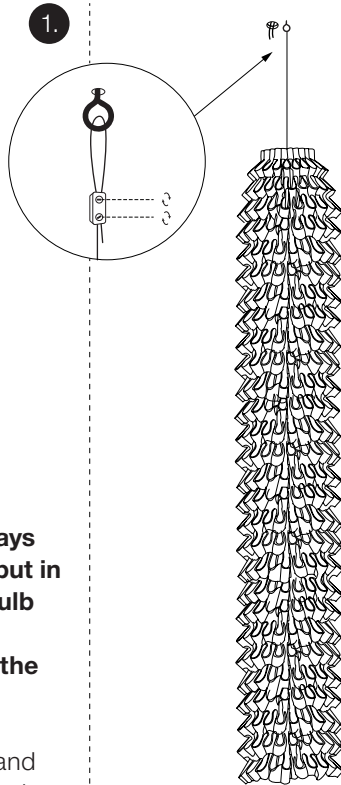

Hang the Crown by attaching the suspension cable to hook or JSPR ceiling fastener. Correct the length at any time.

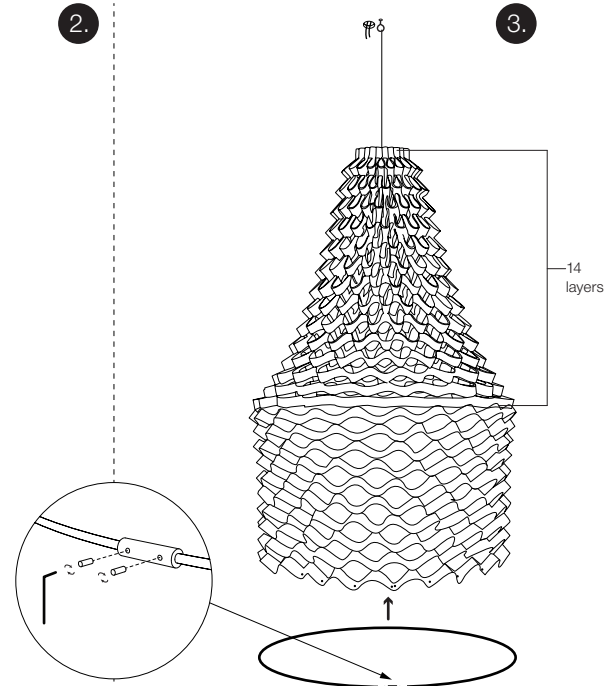

Assemble the ring with a fastener provided. Use hex key to tighten. Place this ring inside the Crown 14 layers from top.

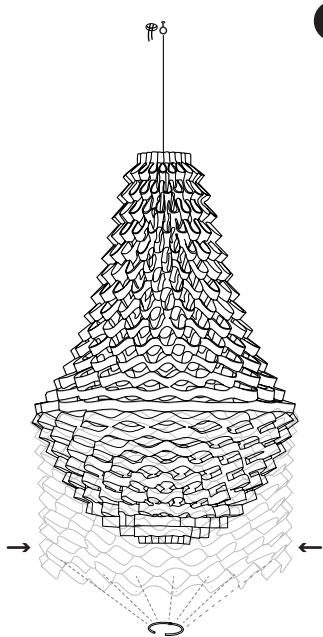

Close the bottom of the Crown with small clip-ring provided. Pull through all holes of the bottom layer.

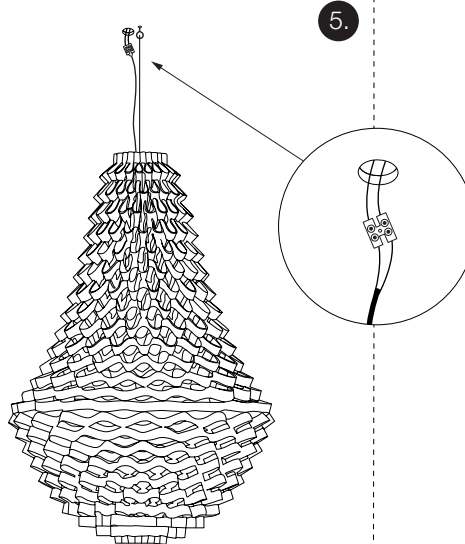

Finally connect the lamps electric wire to the house wire. Arrange all layers/flaps that have turned inside out to match drawing.

CONTACT

**JSPR**  
T +31 (0) 402692111  
INFO@JSPR.EU  
WWW.JSPR.EU

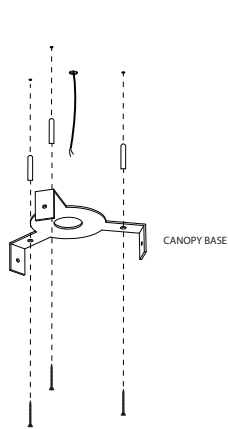

1. Mark holes in the ceiling based on canopy measurements. Attach canopy base plate using screws and plugs (by client, depending on ceiling material).

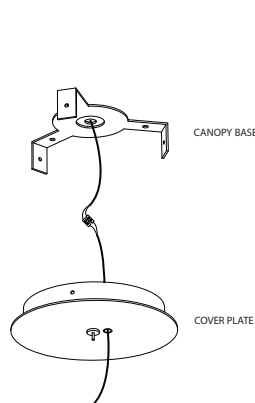

2. Guide the lamps electricity cable to the canopy cover plate. Connect the house electricity cable to the lamps electricity cable. Use a connection block to make a safe connection.

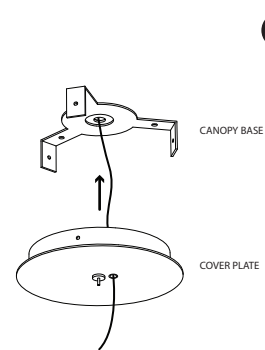

3. Once the electricity cables are connected attach the cover plate to the premounted canopy base.

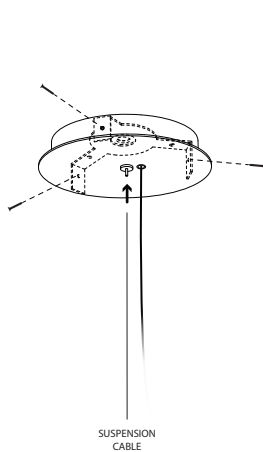

4. Fix cover plate to the base plate with three/four included screws. Once tightly fixed proceed to hanging the lamp by guiding the lamps suspension cable through the little nozzle located on the canopy. Tuck away any excess electricity cables into canopy.

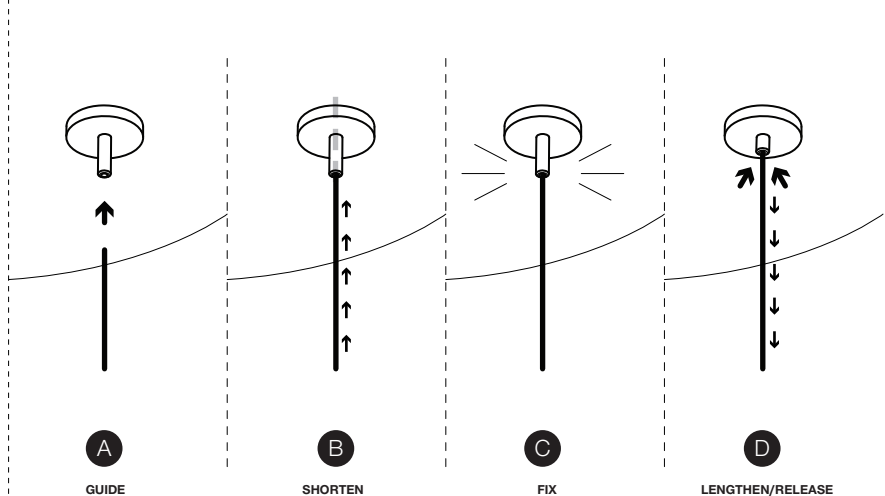

### GUIDING THE CABLE (Steps **A**; **B**; **C**)

Guide the support cable through the tinny nozzle (**A** & **B**). Once reached the desired length of the cable let it go or pull the cable downwards and the ceiling mount will automatically lock (**C**).

### EXTENDING THE CABLE (Step **D**)

To extend the cable, push the little nozzle upwards/inside, the cable will loosen and allow to be pulled out. To fix release the nozzle and the fastener will automatically lock the cable.

CONTACT

**JSPR**  
T +31 (0) 402692111  
INFO@JSPR.EU  
WWW.JSPR.EU

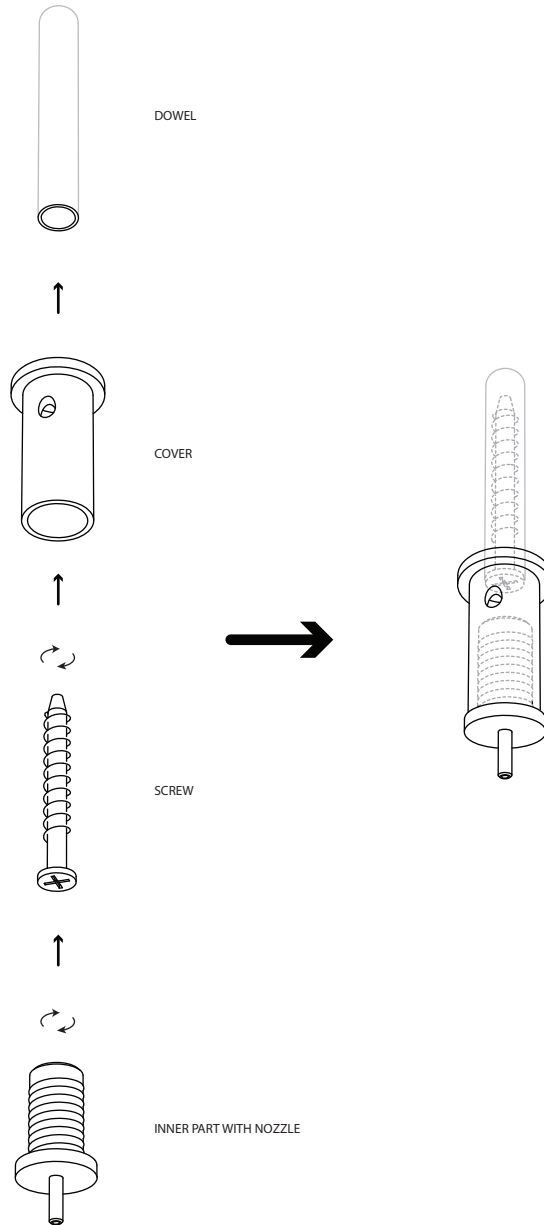

Drill hole in the desired location in the ceiling, place a dowel in the hole (dowel and screw by client). Fasten the cover of the cable fastener with a screw by guiding it through the cover into the dowel. Once the cover is fastened screw in the inner part of the cable fastener.

Proceed to the next page of this manual for information on using this cable fastener.

CONTACT

JSPR  
T +31 (0) 402692111  
INFO@JSPR.EU  
WWW.JSPR.EU

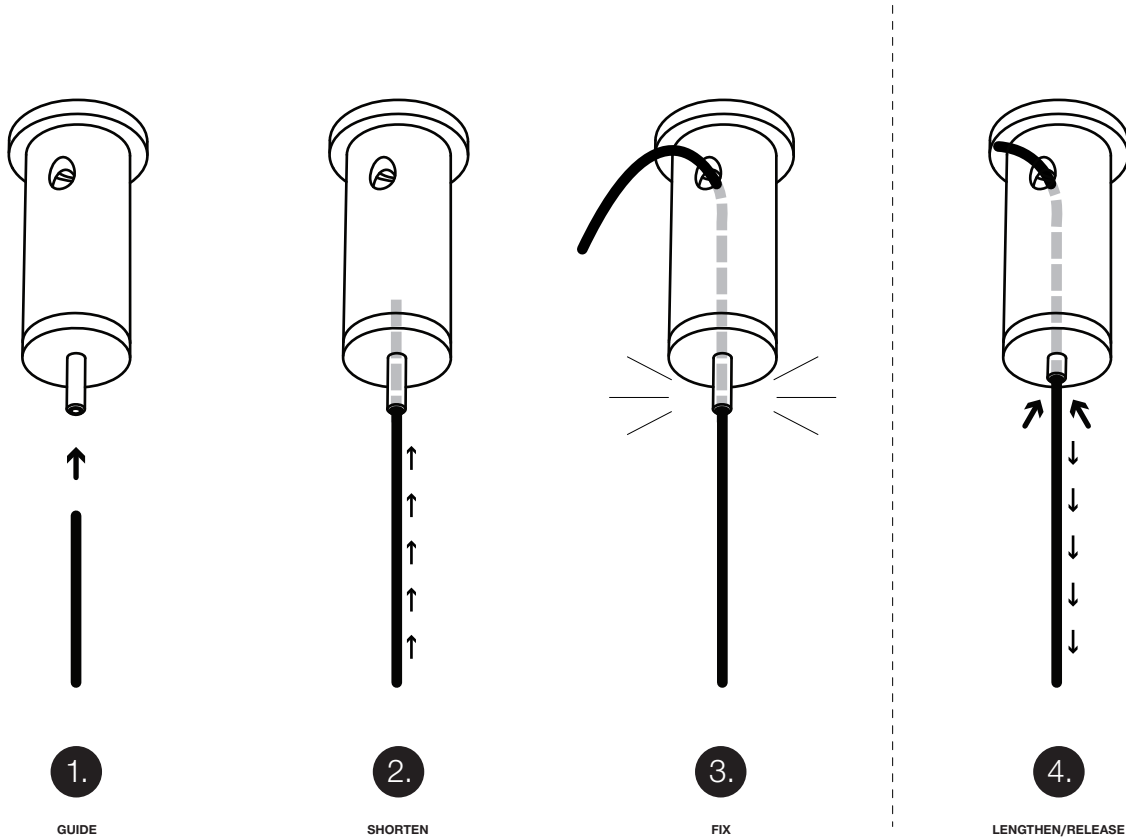

### GUIDING THE CABLE (Steps 1 - 3)

Once the cable fasteners are securely attached to the ceiling, guide the support cable through the tinny nozzle (1 & 2). Once reached the desired length of the cable let it go or pull cable downwards and the cable fastener will automatically lock (3).

### EXTENDING THE CABLE (Step 4)

To extend the cable, push the little nozzle upwards/inside, the cable will loosen and allow to be pulled out. To fix release the nozzle and the fastener will automatically lock the cable.

After achieving desired length of the lighting fixture trim any excess cables.

### CONTACT

JSPR  
T +31 (0) 402692111  
INFO@JSPR.EU  
WWW.JSPR.EU